

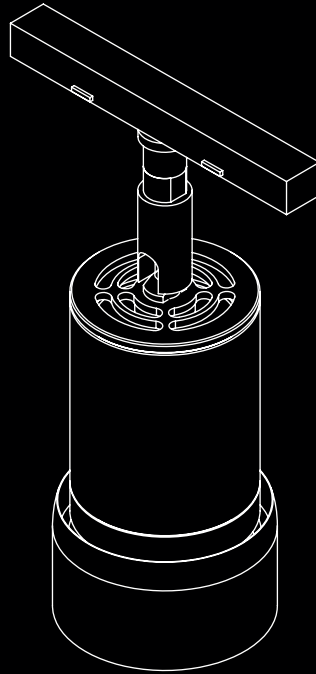

**ORIGAMX**  
BY THE BLACK TANK



**USER MANUAL**



### **Your OrigamX Fixture**

Product Description.....	5
What's In the Box.....	6

### **OrigamX Operation**

DMX/RDM Mode .....	7
RDM Command List .....	8
Advanced DMX Options .....	9
DMX Channel Layout.....	10
4CA CCT Mode DMX Values .....	11

### **Power Options**

OrigamX Hub .....	12
Track Mounted.....	13
Stand Alone .....	14
Power and Data Pinout Diagram .....	15

## **OrigamX Support**

FCC Warning.....	16
General Precautions .....	17
Warranty .....	18

## Product Description

OrigamX is a specification grade architectural lighting system which was developed to be the smallest, lightest, high power LED light available. The system integrates Black Tank's patented heat sink and Hybrid Driver Technology (PWM/Current Control) along with proprietary circuitry and firmware.

The fixture enables dynamic control via DMX/RDM, can be configured in a variety of LED and optic configurations and may be integrated with different housing designs to support the aesthetics of its environment.

The name OrigamX is a combination of Origami, the art of folding flat objects into alternate forms and structures, and "X" to highlight the technology. The core of the OrigamX system is the light engine, which starts as a proprietary flat circuit design and is folded to into module which can be combined with precisely binned LEDs, hand selected optics and incorporated into different housing designs to match specific aesthetic and installation requirements.

## What's In the Box

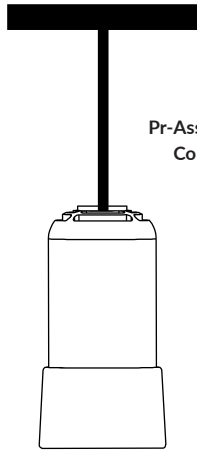

Pr-Assembled Track Configuration

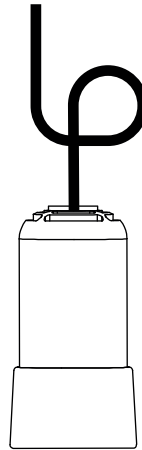

Extended Length of CAT5 Cable for Easy Installation

**Your Custom OrigamX Module including LED Color, Housing, Optics and Mounting Option.**

In DMX mode, the unit is controlled by the data it receives on the RJ45 connector located on the rear of the fixture. The RJ45 also serves as a power input. The number of DMX channels required to control the fixture is dependent on the factory setting in use (for example - four color OrigamX Fixtures use four DMX Channels while one color OrigamX Fixtures use one).

### **RDM (Remote Device Management):**

OrigamX Fixtures have RDM (Remote Device Management) functionality. RDM allows bidirectional control and communication over the CAT5 cable. See the next page for RDM Command List.

### RDM Command List:

- DISC\_UNIQUE\_BRANCE
- DISC\_MUTE
- DISC\_UN\_MUTE
- STATUS\_MESSAGES **G**
- STATUS\_ID\_DESCRIPTION **G**
- SUPPORTED\_PARAMETERS **G**
- DEVICE\_INFO **G**
- DEVICE\_MODEL\_DESCRIPTION **G**
- MANUFACTURER\_LABEL **G**
- DEVICE\_LABEL **G/S**
- SOFTWARE\_VERSION\_LABEL **G**
- DMX\_PERSONALITY **G/S**
- DMX\_PERSONALITY\_DESCRIPTION **G**
- DMX\_START\_ADDRESS **G/S**
- SENSOR\_DEFINITION **G**
- SENSOR\_VALUE **G**
- CURVE **G/S**
- CURVE DESCRIPTION **G**
- OUTPUT\_RESPONSE\_TIME **G/S**
- OUTPUT\_RESPONSE\_TIME\_DESCRIPTOR **G**
- MODULATION\_FREQUENCY **G/S**
- MODULATION\_FREQUENCY\_DESCRIPTOR **G**
- DEVICE\_HOURS **G**
- DEVICE\_POWER\_CYCLES **G**
- IDENTIFY\_DEVICE **G/S**
- RESET\_DEVICE **S**

**G = GET   S = SET**



### **8 or 16 bit mode**

The fixture can run in either 8 bit or 16 bit DMX Mode. In 8 bit mode, the OrigamX module accepts one DMX channel for each color. In 16 bit mode, two channels are required for each color. The first channel is the coarse setting and the second channel is the fine setting. For the DMX channel layout see the next page.

### **Filament Fade**

An incandescent lamp has a slight delay, or lag with changing intensities, whereas an LED responds instantly. The difference is most noticeable during a theatrical black out. The OrigamX Module can emulate an incandescent lamp by selecting one of the Filament Fade settings.

### **PWM Frequency**

OrigamX Modules can be set to operate at 4kHz or 16kHz using RDM.

## DMX Channel Layout

### Personality 1 (8 BIT)

#### RGBA/W

- 1 - Red
- 2 - Green
- 3 - Blue
- 4 - Amber/White
- 5 - Zoom (If Available)

### Personality 3 (8 BIT + Mstr)

- 1 - Red
- 2 - Green
- 3 - Blue
- 4 - Amber/White
- 5 - Master Dimmer
- 6 - Zoom (If Available)

### Personality 5 (8 BIT + Sktz)

#### IF SKITZO IS BELOW 50%

- 1 - Red
- 2 - Green
- 3 - Blue
- 4 - Amber/White
- 5 - Master Dimmer
- 6 - Zoom (If Available)
- 7 - Skitzo

### Personality 2 (16 BIT LEGACY)

#### RGBA/W

- |                  |                        |
|------------------|------------------------|
| 1 - Red Coarse   | 5 - Blue Coarse        |
| 2 - Red Fine     | 6 - Blue Fine          |
| 3 - Green Coarse | 7 - Amber/White Coarse |
| 4 - Green Fine   | 8 - Amber/White Fine   |

### Personality 4 (CCT MODE)

- 1 - Color Temp
- 2 - Intensity
- 3 - Zoom (If Available)

#### IF SKITZO IS ABOVE 50%

- 1 - Color Temp
- 2 - N/A
- 3 - N/A
- 4 - N/A
- 5 - Intensity
- 6 - Zoom (If Available)
- 7 - Skitzo

## 4CA CCT Mode DMX Values

There are 50 recipes from 2000K to 7000K. The Color temperature will increment 100° every 5 DMX steps. See Below:

<b>DMX Value</b>	<b>Color Temp.</b>	<b>DMX Value</b>	<b>Color Temp.</b>	<b>DMX Value</b>	<b>Color Temp.</b>
<b>1</b>	2000K	<b>86</b>	3700K	<b>171</b>	5400K
<b>6</b>	2100K	<b>91</b>	3800K	<b>176</b>	5500K
<b>11</b>	2200K	<b>96</b>	3900K	<b>181</b>	5600K
<b>16</b>	2300K	<b>101</b>	4000K	<b>186</b>	5700K
<b>21</b>	2400K	<b>106</b>	4100K	<b>191</b>	5800K
<b>26</b>	2500K	<b>111</b>	4200K	<b>196</b>	5900K
<b>31</b>	2600K	<b>116</b>	4300K	<b>201</b>	6000K
<b>36</b>	2700K	<b>121</b>	4400K	<b>206</b>	6100K
<b>41</b>	2800K	<b>126</b>	4500K	<b>211</b>	6200K
<b>46</b>	2900K	<b>131</b>	4600K	<b>216</b>	6300K
<b>51</b>	3000K	<b>136</b>	4700K	<b>221</b>	6400K
<b>56</b>	3100K	<b>141</b>	4800K	<b>226</b>	6500K
<b>61</b>	3200K	<b>146</b>	4900K	<b>231</b>	6600K
<b>66</b>	3300K	<b>151</b>	5000K	<b>236</b>	6700K
<b>71</b>	3400K	<b>156</b>	5100K	<b>241</b>	6800K
<b>76</b>	3500K	<b>161</b>	5200K	<b>246</b>	6900K
<b>81</b>	3600K	<b>166</b>	5300K	<b>251</b>	7000K

### OrigamX Hub

To connect OrigamX Modules to the Hub, simply plug the Hub into AC power and then connect it to a DMX control source using a 5-pin DMX cable. From there, connect up to 12 Modules to the output ports on the Hub using standard CAT5e Ethernet cables.

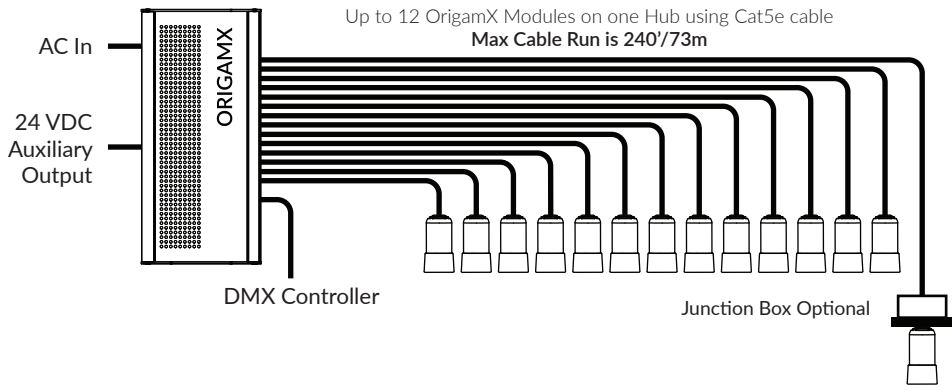

**NOTE: Do NOT Hot Swap fixtures when using OrigamX Hub**

### Track Mounted

To connect OrigamX Modules to a track simply insert the track head with connected module into to low voltage track. The low voltage track can be supplied by a 12-24VDC Class 2 power supply or by utilizing the Auxiliary port on the back of the Hub.

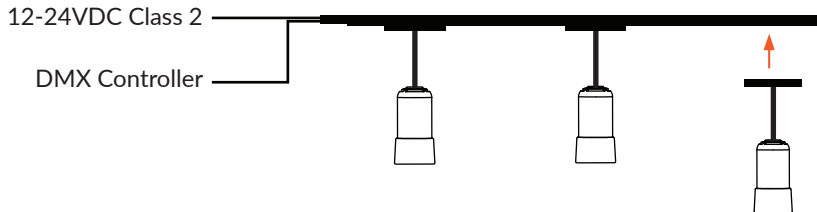

### Stand Alone

Stand alone mode is simply a power only option, where no data is supplied to the fixture. With this configuration you will need to have the light reconfigured with custom modes which can be setup at the time of order. These modes include Preset, Colorwash and Fixed Color.

12-24VDC  
Class 2



## Power Options

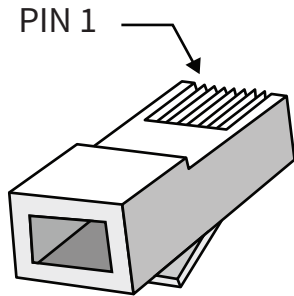

### Pinout Chart

Channel	Color Pair	RJ-45 Pins
Data+	White/Orange	1
Data-	Orange	2
Power-	White/Green	3
Power+	Green	6
Power-	White/Blue	5
Power+	Blue	4
Data Com	White/Brown	7
Serial In	Brown	8

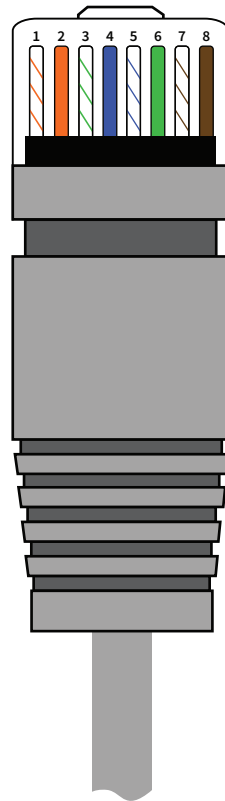

## FCC Warning

This equipment has been tested and found to comply with the limits for a Class B digital device, pursuant to part 15 of the FCC Rules. These limits are designed to provide reasonable protection against harmful interference in a residential installation.

This equipment generates, uses and can radiate radio frequency energy and, if not installed and used in accordance with the instructions, may cause harmful interference to radio communications.

However, there is no guarantee that interference will not occur in a particular installation. If this equipment does cause harmful interference to radio or television reception, which can be determined by turning the equipment off and on, the user is encouraged to try to correct the interference by one or more of the following measures:

- Reorient or relocate the receiving antenna.
- Increase the separation between the equipment and receiver.
- Connect the equipment into an outlet on a circuit different from that to which the receiver is connected.
- Consult the dealer or an experienced radio/TV technician for help.



## General Precautions

1. Before use, make sure all safety points are secured.
2. There are no serviceable parts on the fixture.
3. **ALWAYS** adhere to safety instructions and warnings, including any and all instructions set forth in the Product Specifications.
4. To allow for proper cooling, airflow must not be restricted through the front and rear of the fixture - do not block off the front or rear panel.
5. For Dry locations/Indoor use only.
6. Do NOT Hot Swap Fixtures when using OrigamX Hub

## Warranty

The Black Tank warrants that, under normal use in accordance with the applicable user manual, the Product shall, at the time of delivery to Buyer and for a period of sixty (60) months from the date of delivery (or such other period as may be agreed upon in writing by the parties), be free from defects in material or workmanship and shall substantially conform to The Black Tank' specifications for such Product, or such other specifications as The Black Tank has agreed to in writing, as applicable. The non-conforming or defective Product shall become The Black Tank' property as soon as they have been replaced or credited.



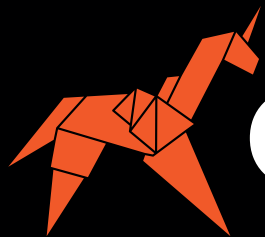

**ORIGAMX**

BY THE BLACK TANK